

SYSTEME 85

35 à 50 C

INTÉGRÉ INDIVIDUEL

KIT 3KW TOITURE ARDOISE

Système (35à50C) intégré individuel Kit 3kw Toiture ardoise
 35x50C integrated roof mounting system - 3kW kit for slate roof
 KIT 3kW Integración individual 35x50C con marco
 traditionelle Bedachungsanlage für polykristalline oder monokristalline
 Module mit Rahmen

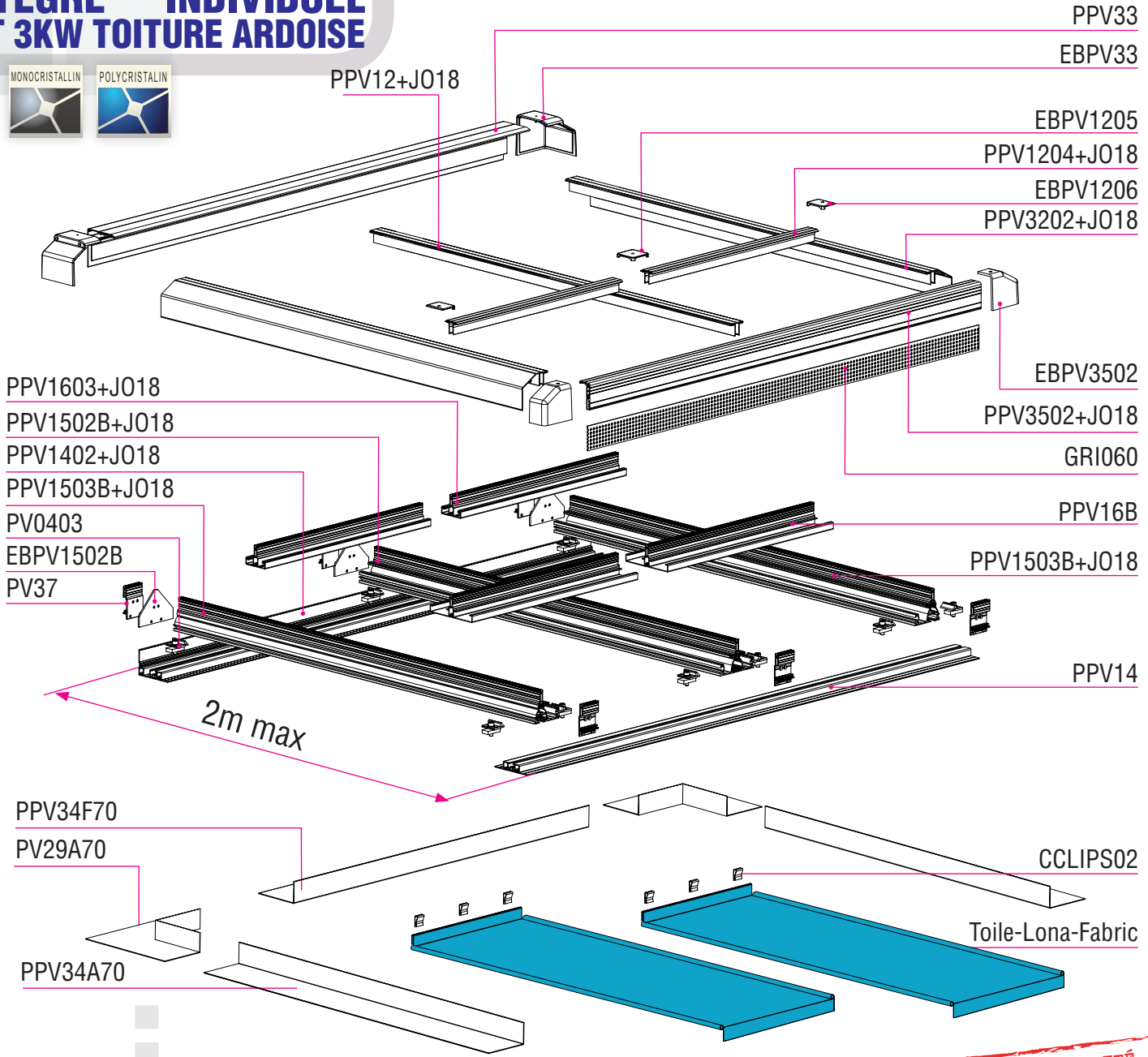

SYSTÈME BREVETÉ
 PATENTED SYSTEM
 SISTEMA PATENTADO
 N° P200930027

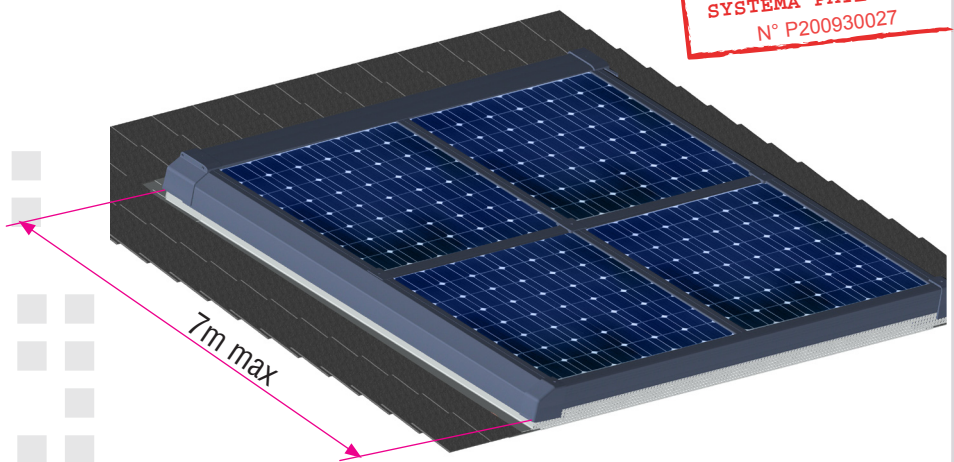
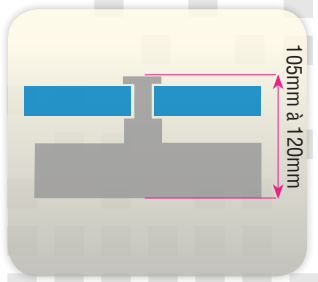

KIT 3kW85 INTÉGRÉ 85 INDIVIDUEL



SYSTEME 35 à 50 C INTÉGRÉ INDIVIDUEL KIT 3KW Toiture ardoise

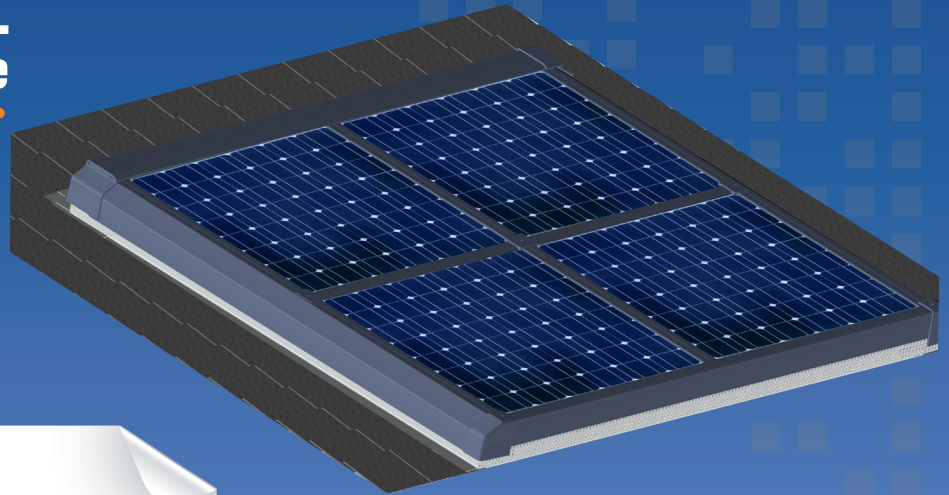

+ PLUS PRODUIT

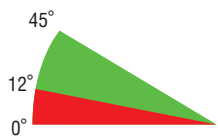

Inclinaison
Pitch adjustment
Pendiente
Neigungswinkel

- Installation rapide
- Intégré toiture ardoise
- Esthétique & Design

PANNEAU D'ÉPAISSEUR DE 35MM À 50MM
For 35mm to 50mm thick panels
Panel de grosor de 35mm a 50mm



INSTALLATION PAYSAGE PRÉCONISÉE
Instalación horizontal
Horizontal



POUR PANNEAUX CADRÉS
Paneles con marco
Framed solar panels

Composants de la structure :

Profilé en aluminium
Pièce fonderie aluminium (AS13)
Visserie inox A2 RAL 7016 +
rondelle EPDM
Joint en EPDM

Finition :

- en brut
- en laqué sablé téflonné RAL 7016

Chevron
inter-panneaux

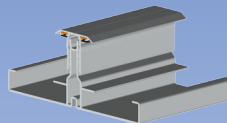

Rail porteur

Option joint
(Rupture thermique)

Fixation entraxe 82 mm

Cage de réglage, et
fixation des chevrons

Raccords

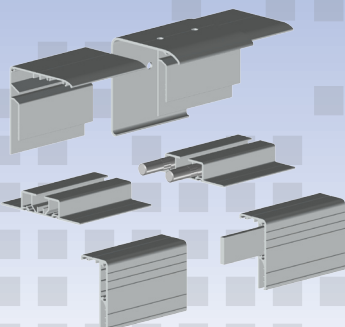

Chevron latéral

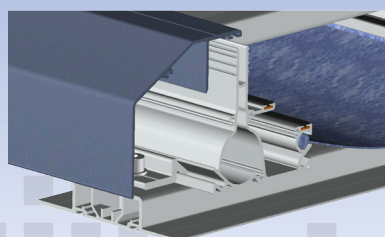

Chevron central

