

SYSTEME 95 INTÉGRÉ 95 COMPLET (35 à 50 C) INDUSTRIEL ou AGRICOLE

Système intégré complet 95 (35à50C) industriel ou agricole
95 (35 to 50 C) - Integrated mounting system for industrial or agricultural buildings
Sistema 95 integrado tejado industrial o agrícola 95 (35-50) C con marco
Dachintegrierte Unterkonstruktion 95 für industrielle oder landwirtschaftliche Bedachungsanlage



PPV3304
PPV3303

EBPV3304

PPV12+JO18

EBPV1205

EBPV1206

PPV32+JO18

EBPV32

GRI60

PPV3502+JO18+JO25

PPV16B

PPV1602

EQA32X32

EBPV1502B

PPV1502B

PV37

PPV14

PV0403

2.00m max

PPV3403

PV2904+CPV02

PPV34

CCLIPS02

Toile-Lona-Fabric

SYSTÈME BREVETÉ
PATENTED SYSTEM
SYSTEMA PATENTADO
N° P200930027

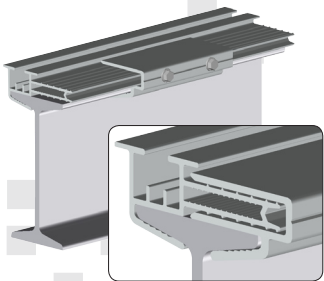

PPV1405 - PV1406

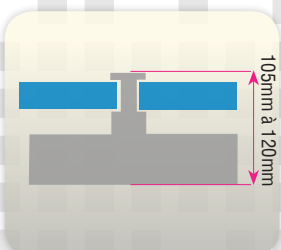

105mm à 120mm

7m max

MITJAVILA



INTEGRATION COMPLÈTE INDUSTRIELLE OU AGRICOLE

SYSTEME INTÉGRÉ 95

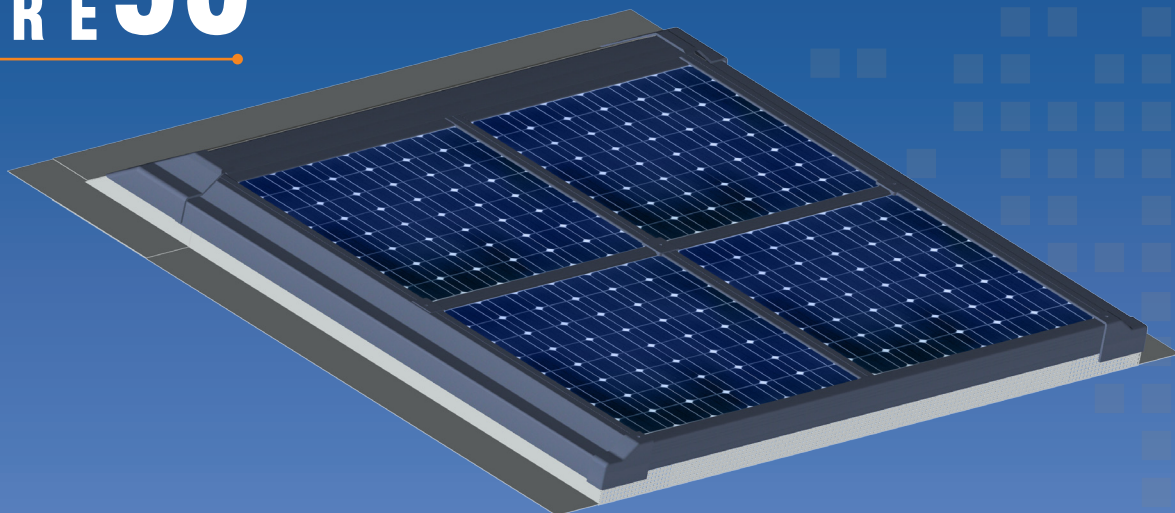

+ PLUS PRODUIT

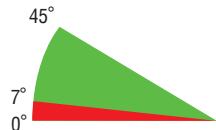

Inclinaison
Pitch adjustment
Pendiente
Neigungswinkel

- Installation rapide
- Esthétique & Design

PANNEAU D'ÉPAISSEUR DE 35MM À 50MM
For 35mm to 50mm thick panels
Panel de grosor de 35mm a 50mm



INSTALLATION PAYSAGE PRÉCONISÉE
Instalación horizontal
Horizontal



POUR PANNEAUX CADRÉS
Paneles con marco
Framed solar panels

Composants de la structure :

Profilé en aluminium
Pièce fonderie aluminium (AS13)
Visserie inox A2 RAL 7016 +
rondelle EPDM
Joint en EPDM
Colle pour jointure (Résine epoxy)

Finition :

- en brut
- en laqué sablé téfloné RAL 7016

Raccords

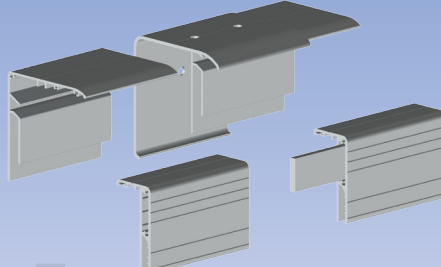

Chevron inter-panneaux

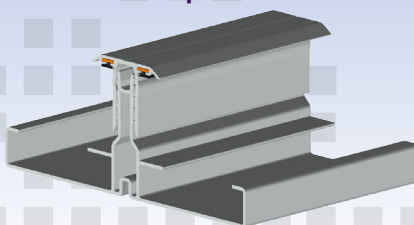

Chevron central

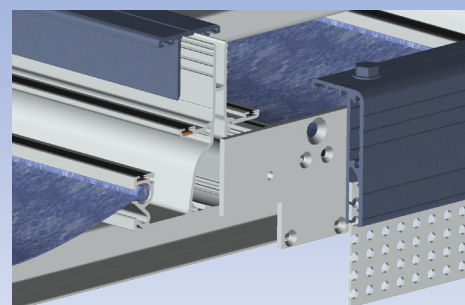

MITJAVILA 